

EMP Surge Protector/Filter for analog signals up to 15V / 0.5 A USS-1-15V

Effectively protects one wire of an analog telephone line or control signal

Protects against overvoltages produced by NEMP / HEMP, lightning or other transients

Coordinated multi-stage protection and filter designed for low residual voltages

High surge current capability

Feed-through type steel body for direct installation to wall of Faraday cage

Threat-level tested against HEMP according to MIL-STD-188-125, short and medium



Product

The Meteolabor® USS-1 series overvoltage protector/filter elements consist of coordinated coarse and fine protection stages in combination with filtering components. This ensures best protection of sensitive equipment against very fast transient overvoltages (e.g. NEMP / HEMP). Surge currents up to 20 kA can be handled. In addition high frequency interferences are filtered efficiently within a wide range.

The unique mechanical design offers easy installation and compact fitting into Faraday cages, shielded rooms and mechanical enclosures. Single point of entry concepts can be simply realized to achieve best possible EMI behavior of penetrating feed-through elements.

Applications

The Meteolabor® USS-1-15V surge protector/filter is intended to protect one wire of an analog signal or power line of grounded circuits up to 15V / 0.5 A. It can be used for all kind of circuits to be protected against destructive overvoltage effects caused by NEMP / HEMP or lightning strikes. USS-1-15V has a typical bandwidth of 300 kHz and passes signals with a risetime of 1µs or higher.

USS-1-15V has been used in many fixed installations (buildings, underground shelters etc.) as well as in portable and mobile systems like containers or shelters and vehicles, which were successfully EMP-tested on threat-level according to RS105 of MIL-STD-461F.

Technical Data USS-1-15V

Application	signal line	Analog signals up to 12V / 0.5 A / 300 kHz, protects one wire
Maximum operating voltage U_{Max}	± 15 V DC	Absolute maximum values
Maximum operating current I_N	0.5 A	$T_{amb} = 40$ °C, short-circuit current must be limited to 0.5 A
DC resistance	< 5 Ω	
Leakage current at U_{Max}	< 5 μ A	Wire \rightarrow ground / case
Max. surge current I_{Max}	20 kA	Wire \rightarrow ground / case, shape 8/20 μ s
Max. lightning impulse current I_{imp}	2 kA	Wire \rightarrow ground/case, shape 10/350 μ s, at least 1 pulse
Residual voltage (surge 8/20 μ s)	< 30 V	wire \rightarrow ground / case, worst case depending on surge amplitude
Average attenuation	typ. 50 dB	at 50 Ω , up to 1 GHz
Low pass cut-off frequency	typ. 300 kHz	3 dB
Capacity to ground	typ. 7 nF	Capacity to ground / case
Operating temperature range	- 40 °C / + 85 °C	
Connection terminals	2.8 / 6.3 mm	Choice of FASTON flat receptacle, solder or screw connection
Max. allowed installation torque	12 Nm	Not to be exceeded under all circumstances
Dimensions (Overall)	58 x 16 x 14 mm	details see reverse page
Weight	23 g	

— CLICK HERE —

REQUEST QUOTE

www.geminelec.com

PAGE 1 OF 2 PAGES

(800) 882-6414 | sales@geminelec.com



Dimensions [mm]

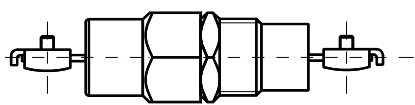
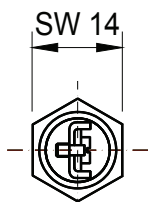
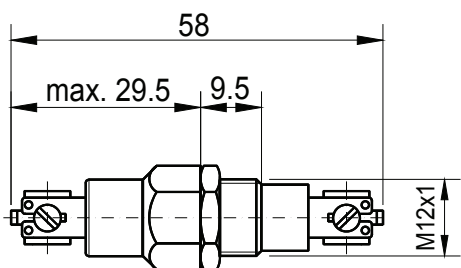

unprotected side protected side

case / ground, torque max. 12 Nm

Installation Layouts

Standard drilling layout for USS-1 series with standard hexagonal nut (included, spanner size 14 mm)

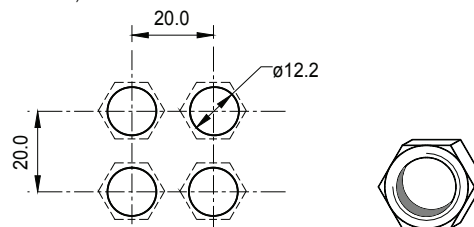

Space saving "honeycomb" mounting hole layout for USS-1 series (requires optional slotted nut USS-SM1 and USS-SK1 spanner)

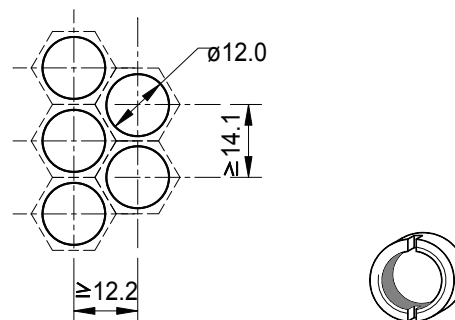

Installation Notes

- The USS-1 series EMP protector/filters shall be installed by electrically skilled personnel.
- The electrical wiring must be done according to local regulations.
- The max. values stated in this datasheet must not be exceeded under any circumstances.
- Do not exceed max. installation torque of 12 Nm as this can destroy the device.
- USS-1 series EMP protector/filters may be directly installed into the wall of a Faraday cage as feed-through device. Otherwise the cabling on the protected side must be shielded for best performance.
- For space-saving installation of multiple protectors a "honeycomb" layout is recommended (see drawings).

General Recommendations for Protection Installation

- In order to achieve the full performance of a protection circuit the application of good-practice EMC design techniques is necessary for the whole system to be protected.
- For EMP-protection usually a shield as an electromagnetic barrier to protect a certain volume is necessary. This shield avoids coupling of radiated disturbances inside the protected volume. In addition to shielding all penetrating wires must be protected from conducted transient interferences by an appropriate POE (point of entry) protection.
- Use tested, high quality POE (point of entry) protection elements for all wires entering an electromagnetic shield and install these as feed-through devices, e.g. the Meteolabor® USS-1, USS-2, USP, CSP or PLP series.

Ordering Information / Part Number

- USS-1-15V** Surge protector/filter EMP USS1-15V
1 piece required per wire
- USS-SM1** slotted nut (optional)
- USS-SK1** special box-spanner for slotted nut (optional)



Caution
Maximum torque for installation screw shall not exceed 12 Nm

— CLICK HERE —

REQUEST QUOTE

www.geminelec.com

PAGE 2 OF 2 PAGES

(800) 882-6414 | sales@geminelec.com